

BÖLLHOFF

RIVKLE®

Power hand tools for RIVKLE® blind rivet nuts and studs



Contents

	Page
RIVKLE® - Blind rivet nuts	3
Setting methods	3
RIVKLE® - Power hand tools offer overview	6
Setting method controlling	8
RIVKLE® P2005	9
Pressure controlled installation equipment	10
RIVKLE® P1007	11
RIVKLE® P2007 / RIVKLE® P2007 PN	12
RIVKLE® P3007 / RIVKLE® P3007 PN	13
RIVKLE® EPX009 – Process control	14
RIVKLE® B2007 – Battery tool	16
RIVKLE® EPK Compact – RIVKLE® EPK HP	18
Mono force cartridges	20
RIVKLE® FC340 – Force controller	20
How to? – Tooling change	21
Tooling for power hand tools	22



See also our automation offer



RIVKLE® – Setting methods

The BÖLLHOFF recommended installation is the “pull method”.
RIVKLE® can also be installed using a press.

1 - Pressure setting methods

The “pressure method” consists of: Spin on ①, Insert ②, Upset ③ and Spin off ④ cycles.

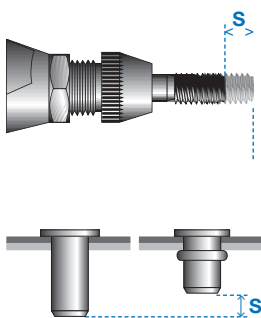
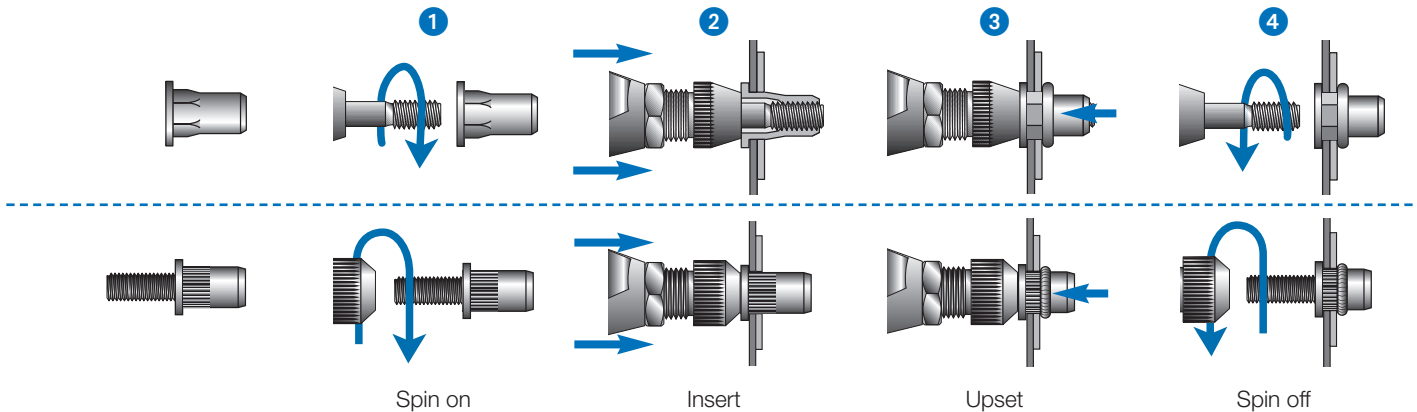

1.1 Stroke setting method

The operator adjusts the stroke limit on the setting tool in accordance with the values shown in the RIVKLE® catalogue tables.

The setting tool applies the maximum force and automatically stops when the preset stroke is reached (mechanical stop).

- Advantages:**
- Fast and simple process
 - Ideal for assemblies with no variation in sheet thickness
 - Well adapted for M3 Aluminum

1.2 Pressure setting method

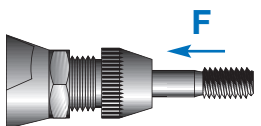

The operator adjust the force in accordance with the value shown in the RIVKLE® catalogues tables.

The setting tool adjusts the required force which insures the correct setting quality whatever the thickness of the support.

This setting principle is particularly well suited to workpieces with variable thickness (plastic parts, various layers...).

- Advantages:**
- Optimised setting into panels with thickness variations
 - Doesn't damage the RIVKLE® in case of double setting.
 - Permits quality control (force indicator...)
 - Optimized mandrel life
 - Can also set different types of RIVKLE® with one tool and one single setup

2 - Installation force value

The setting force is defined using combination of:

- RIVKLE® installation parameters defined by our laboratory
- Application parameter (tensile strength after assembly and during service)

2-1 RIVKLE® Installation parameters

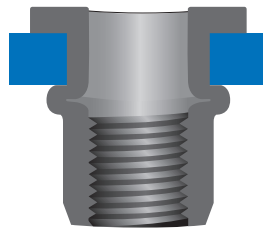

Maximum thickness
(C1)

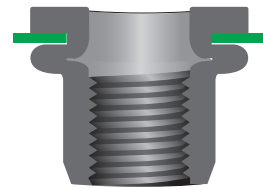

Minimum thickness
(C2)

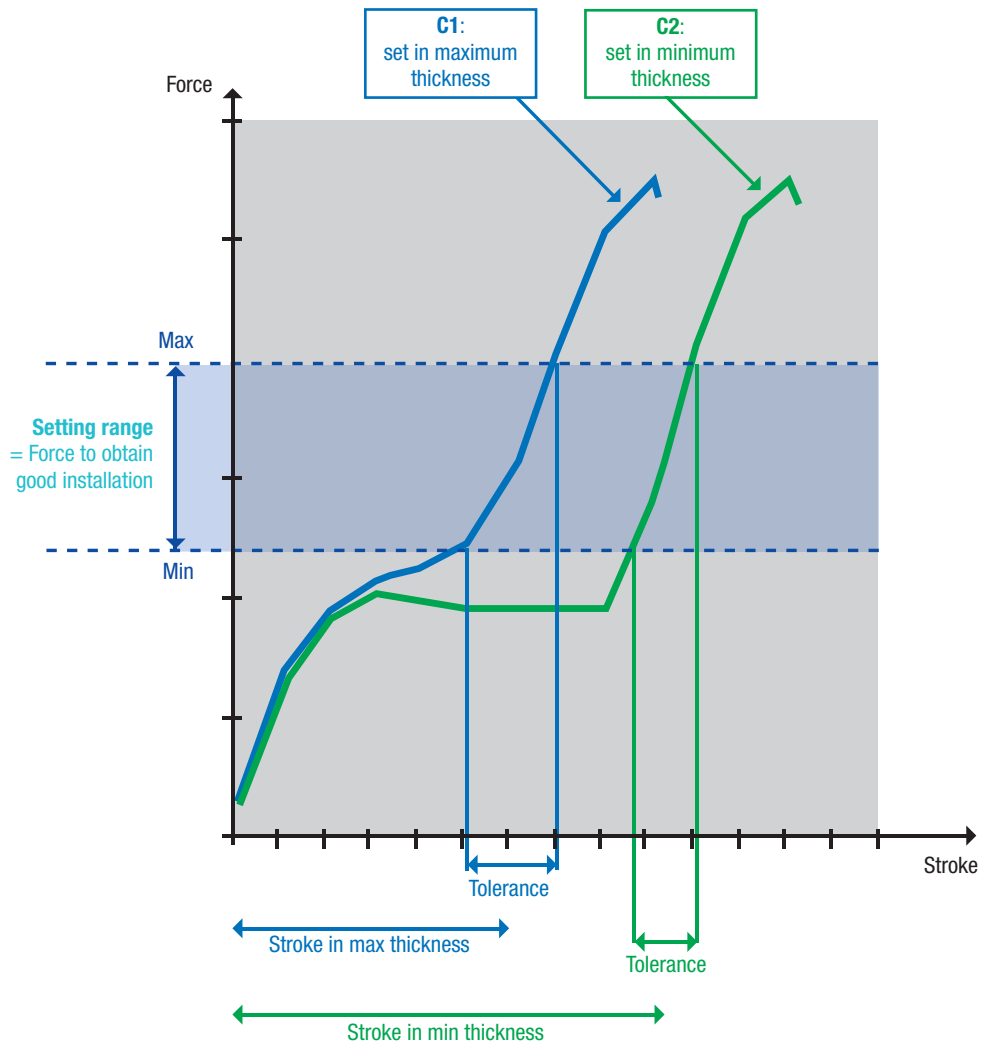

2-2 SCREW parameters

When a assembly is in use, external influences generally increase the tensile strength in the screw ($F_1 > F_0$).

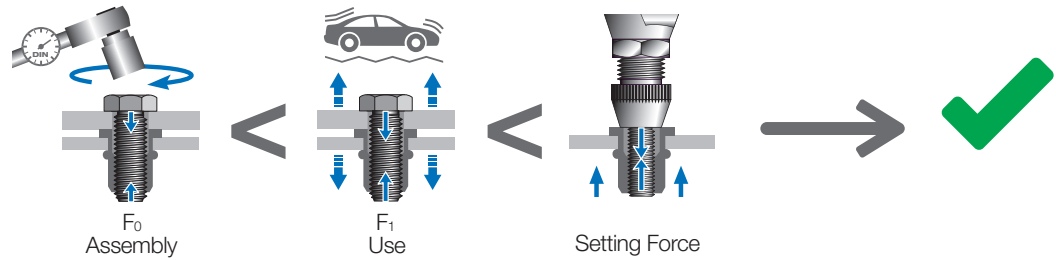

With correct installation, RIVKLE® exhibits the same behaviour as a standard nut.

Results:

1. BÖLLHOFF recommends a setting force higher than the screw tensile strength after clamping, in order to ensure that no re-setting occurs during the life of the RIVKLE®.

Setting force positioning

Ø	8.8			
	Nm*	F ₀ max*		
M4	2,23 Nm	3 830 N	5 500 N	6 800 N
M5	4,43 Nm	6 270 N	8 000 N	10 000 N
M6	7,70 Nm	8 834 N	12 000 N	15 000 N
M8	18,60 Nm	16 219 N	18 000 N	27 000 N

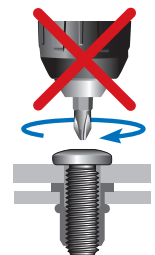

* NFE 25-030 source - 8,8 screw class - Setting conditions B - $0,12 < u < 0,18$ - Steel RIVKLE®

2. BÖLLHOFF does not recommend the use of mechanical screw-drivers for installing RIVKLE®.



Installation force range per diameter & RIVKLE® material

	Steel Force in kN (+/- 10%)	Stainless steel Force in kN (+/- 10%)	Stainless steel A4 Force in kN (+/- 10%)	Aluminium Force in kN (+/- 10%)
M3	3,5	3,5	-	1,9
M4	5,5	5,5	9,5	3,0
M5	8,0	8,0	12,0	3,8
M6	12,0	13,0	15,0	5,5
M8	18,0	20,0	20,0	10,0
M10	21,0	22,0	-	12,0
M12	23,0	28,0	-	15,0
M14	50,0	-	-	-

		Hydro pneumatic and				
						
		RIVKLE® P2005	RIVKLE® P1007	RIVKLE® P2007	RIVKLE® P2007 PN	
Setting technology	Stroke	●				
	Force		●	●	●	
Drive		Hydro pneumatic	Hydro pneumatic	Hydro pneumatic	Hydro pneumatic	
Setting force (kN)	min.	Up to 26*	3,5	3,5	3,5	
	max.	Up to 26*	13	21	14,5	
Ø RIVKLE®	Steel	min.	M3	M3	M4	M4
		max.	M12	M6	M10	M8
	Stainless Steel	min.	M3	M3	M3	M3
		max.	M10	M6	M8	M6
	Aluminium	min.	M3	M3	M5	M5
		max.	M12	M8	M12	M10
Control process	Stroke					
	Force					
Designed for mass production		++	++	++	+	
Production rate / Cycle time		++++	+++	+++	++	
Easy to handle (light & balanced)		++	+++	++	++	
Page		9	11	12	12	

* with 6,5 bar input

** Possible to decrease to 18 000 N with light technical action on the tool

+ good ++++ very good

Hydro electric tools

Semi-automatic tools



RIVKLE® B2007	RIVKLE® P3007	RIVKLE® P3007 PN	RIVKLE® EPX009	RIVKLE® EPK C	RIVKLE® EPK HP
----------------------	----------------------	-------------------------	-----------------------	----------------------	-----------------------

●	●	●	●	●	●
Hydro electric	Hydro pneumatic	Hydro pneumatic	Hydro pneumatic	Pneumatic / Electric	Pneumatic / Electric
3,0	24**	15	Refer to original tool performances (RIVKLE® P1007, P2007 or P3007)	6	20
22	40	25		21	55
M3	M8	M8		M4	M8
M10	M14	M10		M10	M16 / M12 HRT
M3	M8	M8		M4	M8
M10	M12	M10		M10	M12
M4	M8	M12		M6	-
M10	M16	M12		M12	M12 HRT
●	●	●		●	●
●	●	●		Refer to original tool performances (RIVKLE® P1007, P2007 or P3007)	●
++	+	+	+++		++
++	+	+	+++		++
++++	+	+	●	+	
16	13	13	14	18	18

RIVKLE® – How to ensure that a RIVKLE® is correctly set?

Principle

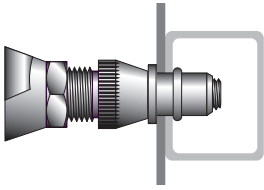

RIVKLE® is mainly used in blind conditions, so the most reliable way to ensure that a RIVKLE® has been set correctly is to ensure that the setting parameters are strictly enforced.

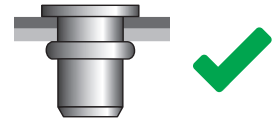

A RIVKLE® correctly set means that it meets all its mechanical characteristics.

Controlling the force setting method (RIVKLE® P1007, P2007, B2007, P3007, EPX009)



Idea is to ensure that the tool has given, and still gives the correct force to the RIVKLE®. Each tool gets its proper force adjustment but the most reliable way to control it is to use a **RIVKLE® FC340 force controller**, as described page 20.

If your tool is dedicated to a unique RIVKLE®, you can fix its force using either a preset cartridge set to a given force value (RIVKLE® PX007), either locking adjustment in the menu (RIVKLE® B2007), which makes it impossible to adjust.

Controlling the stroke setting method (RIVKLE® P2005)

Idea is to ensure that the stroke which is applied on RIVKLE® is correct. By controlling L2 value (only for RIVKLE® with both side access) or by controlling stroke on the tool before setting (S value). Thickness of the application has to be constant.

Example:

Steel | Thin head | Hexagonal | Open

d (mm)	L (mm)	B (mm)	e (min - max) (mm)	$\frac{+0,1}{0}$ (mm)	S (mm)	L2 (mm)	E max (mm)	
M3	10,25	6,0	1,5 - 2,5	5,0	S=3,5-e	6,0	0,65	343 41 030 025
M4	10,8	6,5	0,5 - 3,0	6,0	S=4,5-e	6,2	0,3	343 41 040 030
	13,5		3,0 - 5,5		S=7,0-e			343 41 040 055
M5	14,0	9,0	0,5 - 3,0	7,0	S=4,5-e	9,2	0,4	343 41 050 030
	16,5		3,0 - 5,5		S=7,2-e			343 41 050 055
M6	16,0	11,1	0,5 - 3,5	9,0	S=5,5-e	10,2	0,4	343 41 060 030
	19,0		3,5 - 6,0		S=8,5-e			343 41 060 060
M8	18,0	13,4	0,7 - 3,5	11,0	S=5,2-e	12,5	0,5	343 41 080 030
	21,0		3,5 - 6,0		S=8,2-e			343 41 080 060
M10	22,0	16,0	1,0 - 3,5	13,0	S=6,0-e	16,0	0,5	343 41 100 035
	25,0		3,0 - 6,0		S=8,6-e			343 41 100 060
M12	24,8	18,8	1,0 - 4,0	16,0	S=7,8-e	16,0	1,0	343 41 120 040

e = thickness of parent material in mm

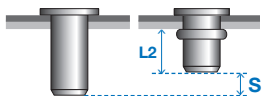

It is best to test a setting on a sample plate with the same thickness as the application and compare the measurement of the RIVKLE® length, before and after crimping - $L - L2 = S$

RIVKLE® – Stroke controlled installation equipment

RIVKLE® P2005 - The stroke setting power hand tool

Stroke controlled hand setting tool, based on hydro-pneumatic technology. Only need to be connected to an air source. The air energy is transformed into hydraulic pressure, which drives the setting operation to the preset stroke.

Advantages:

- Robust
- Fast

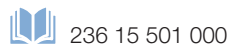

Technical characteristics / Data

Maximum stroke	7,0 mm
Maximum setting force	26 kN with 6,5 bar input
Operating air pressure	5,5 bar min to 7 max
Weight without tooling	2,6 kg
Air consumption	8 L max per cycle
Noise level	< 70 dB (A)
Production rate	35 RIVKLE®/min

Material	Ø RIVKLE®							
	M3	M4	M5	M6	M8	M10	M12	M14
Steel	■	■	■	■	■	■	■	■
Stainless steel	■	■	■	■	■	■	■	■
Aluminium	■	■	■	■	■	■	■	■

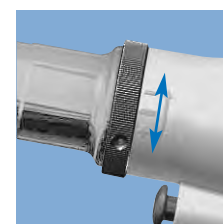
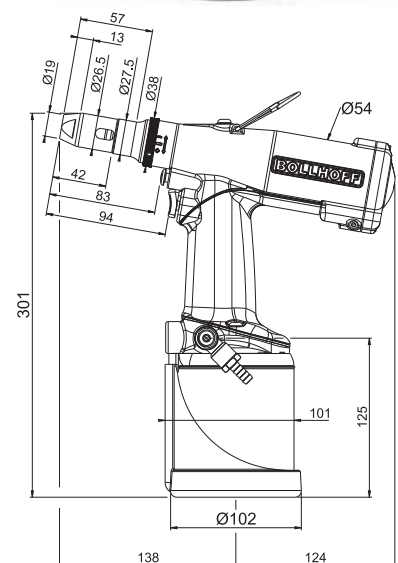

Setting stroke adjustment

RIVKLE® P2005 - Special accessories

RIVKLE® P2005	236 15 500 305	236 15 501 001	282 59 010 820	282 59 010 665	282 59 010 664

For tooling, please refer to page 22

RIVKLE® – Force setting powertool

RIVKLE® P1007 / P2007 / P3007

Theory

Force setting powertool, based on hydro-pneumatic technology. Only needs to be connected to an air source. The air energy is transformed in hydraulic pressure, which drives the setting operation to the preset force. The force adjustment is done on the tool using colour coding, and could be confirmed and/or monitored using force controller RIVKLE® FC340 (see page 20).

Common characteristics



- 1 PUSH/PULL: Push on the mandrel to activate the screwing
- 2 Single press trigger function to complete the whole cycle (Setting + unscrewing)
- 3 Suspension hook
- 4 Cast aluminium body
- 5 Force adjustment cartridge with colour coding
- 6 Reverse button

Packaging

- One power hand tool
- One multi-lingual instruction manual
- One toolkit for the adjustment and maintenance of the equipment



Note: tooling has to be ordered separately (see page 22)

RIVKLE® P1007 - Lightweight tool for speed and accessibility

Advantages:

- Ultra-lightweight and compact
- Suitable for small diameter RIVKLE® nuts and studs
- Precision of the setting force

 236 15 701 000



Technical characteristics / Data





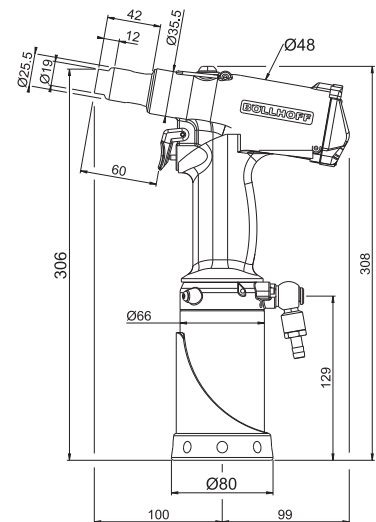



Maximum stroke	7.0 mm
Maximum setting force	13 kN
Operating air pressure	5,5 bar min to 7 max
Weight without tooling	1,8 kg
Air consumption	8 L max per cycle
Noise level	< 70 dB (A)
Production rate	32 RIVKLE®/min

Material	Ø RIVKLE®							
	M3	M4	M5	M6	M8	M10	M12	M14
Steel	■	■	■	■	■	■	■	■
Stainless steel	■	■	■	■	■	■	■	■
Aluminium	■	■	■	■	■	■	■	■



Generic code for a tool with preset force cartridge: 282 52 000 005
It is also possible to get preset cartridge separately. See page 20.

RIVKLE® P1007 - Special accessories

					
RIVKLE® P1007	236 15 700 301	236 15 701 001	 2 - 3 Kg 282 59 010 820	 2,2 - 4 Kg 282 59 010 665	 2,2 - 4 Kg 282 59 010 664

For tooling, please refer to page 22

RIVKLE® – Force setting powertool

RIVKLE® P2007 - Flexible and versatile hydro-pneumatic tool

Advantages:

- Versatile
- Adapted for serial use
- Compatible with various diameters of RIVKLE® nuts and studs
- Ergonomic and well balanced

 236 15 601 000

Technical characteristics / Data

Maximum stroke	7.0 mm
Maximum setting force	21 kN
Operating air pressure	5,5 bar min to 6,5 max
Weight without tooling	2,2 kg
Air consumption	8 L max per cycle
Noise level	< 70 dB (A)
Production rate	32 RIVKLE®/min

Material	Ø RIVKLE®							
	M3	M4	M5	M6	M8	M10	M12	M14
Steel		■	■	■	■	■	■	■
Stainless steel	■	■	■	■	■	■	■	■
Aluminium			■	■	■	■	■	■

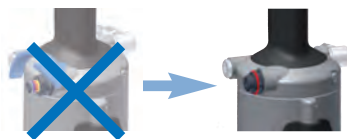

Generic code for a tool with preset force cartridge: 282 52 000 005
It is also possible to get preset cartridge separately. See page 20.

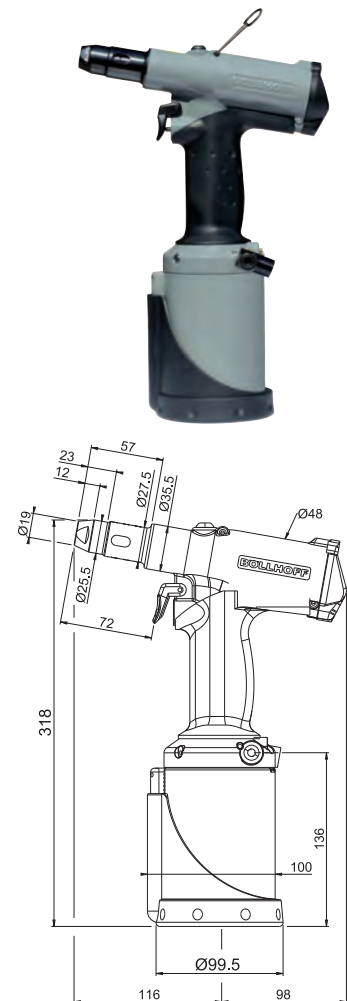

RIVKLE® P2007 PN

Extended stroke, for RIVKLE® Plusnut (slotted RIVKLE®)

 236 15 801 000

Maximum stroke	14,0 mm
Maximum setting force	14,5 kN see page 6 for diameters according to material

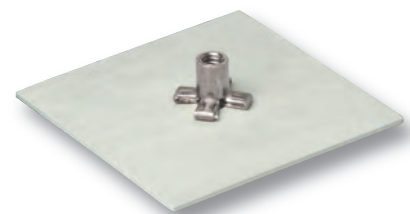

RIVKLE® P2007/P2007 PN - Special accessories

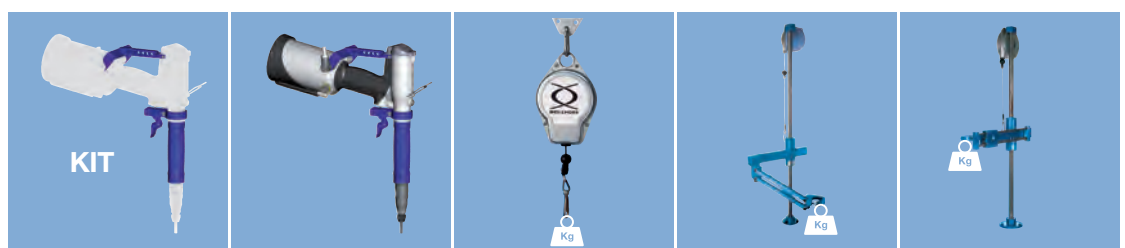

RIVKLE® P2007	236 15 600 301	236 15 601 001	 2 - 3 Kg 282 59 010 820	 2,2 - 4 Kg 282 59 010 665	 2,2 - 4 Kg 282 59 010 664
RIVKLE® P2007 PN		–			

For tooling, please refer to page 22

RIVKLE® P3007 - Powerful and robust construction

Advantages:

- Adapted for production use
- Adapted to large diameters of RIVKLE® blind rivet nuts (M8 to M16)
- Well balanced

 236 15 901 000

Technical characteristics / Data

Maximum stroke	8.0 mm
Maximum setting force	40 kN
Operating air pressure	5,5 bar min to 6,5 max
Weight without tooling	3,4 kg
Air consumption	12 L max per cycle
Noise level	< 70 dB (A)
Production rate	14 RIVKLE®/min

Material	Ø RIVKLE®							
	M4	M5	M6	M8	M10	M12	M14	M16
Steel				■	■	■	■	
Stainless steel				■	■	■		
Aluminium				■	■	■	■	■

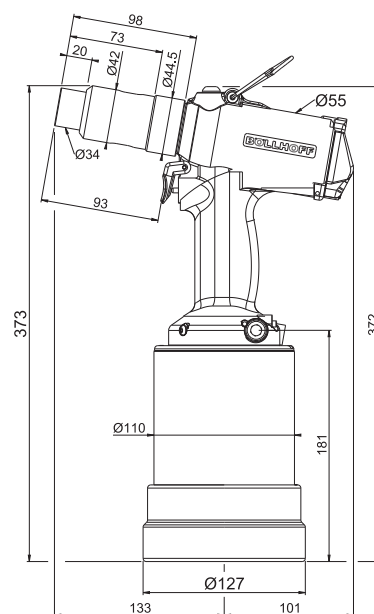

Generic code for a tool with preset force cartridge: 282 52 000 005
It is also possible to get preset cartridge separately. See page 20.

RIVKLE® P3007 PN

Exists with larger stroke, for RIVKLE® Plusnut (slotted RIVKLE®)

 236 16 001 000

Maximum stroke	14,0 mm
Maximum setting force	25 kN see page 6 for diameters according to material

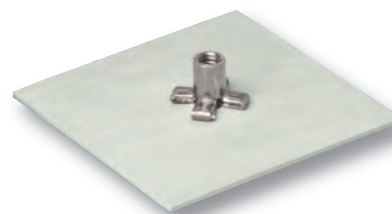

RIVKLE® P3007/P3007 PN - Special accessories



RIVKLE® P3007	236 15 900 301	236 15 901 001	 3 - 5 Kg
RIVKLE® P3007 PN	236 15 600 301	—	282 71 950 924

For tooling, please refer to page 22

RIVKLE® – Force setting powertool - Process control

RIVKLE® EPX009 - Process control

Advantages:

- Validates the conformity of setting by controlling stroke done during setting
- Detailed error reporting for better correction and prevention
- Ensures optimum setting of RIVKLE®
- Teaching mode to adjust all parameter of control



Theory

RIVKLE® EPX009 tool includes hydro-pneumatic tool (based on RIVKLE® P1007, RIVKLE® P2007 or RIVKLE® P3007) connected to a control box unit.

It's the basic process control level, allowing a 100% control on stroke.

Force is defined by classic hydro-pneumatic adjustment device.

We recommend to use a force controller RIVKLE® FC340 (see page 20) for correct set up and monitoring.

Characteristics

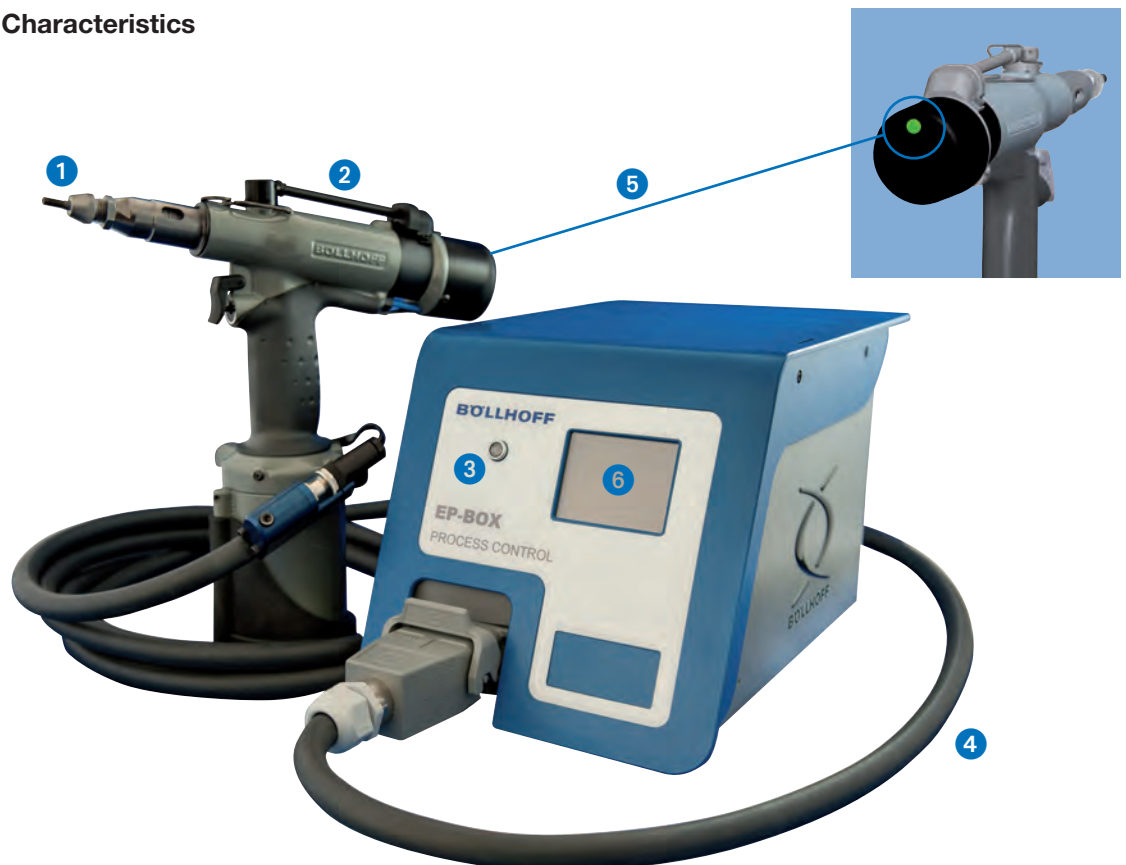

- 1 Available for the complete range of power tools: RIVKLE® P1007 / P2007 / P3007
- 2 Controls process based on stroke monitoring: RIVKLE® EP X009 compares real stroke to the preset value
- 3 LED indicator on EP box and on the rear of the tool (green, orange and red)
- 4 Quick connect multi-energy hose (5 m standard; 10 & 15 m as option)
- 5 Fault acknowledgment on screen (air supply management)
- 6 HMI screen (3,5")

Technical characteristics / Data

Maximum stroke	see chosen tool characteristics (RIVKLE® P1007, P2007 or P3007)
Maximum setting force	
Operating air pressure	
Weight without tooling	
Air consumption	
Noise level	
Production rate	

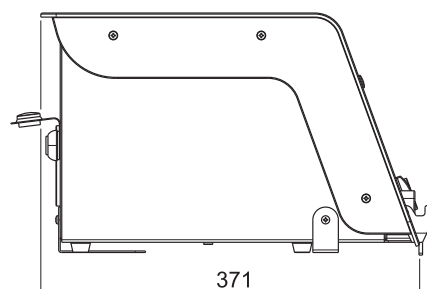
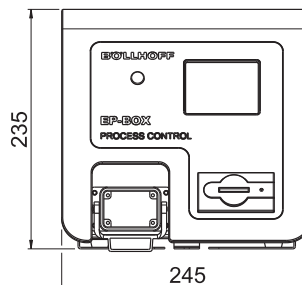

References

	Code number	Ø RIVKLE® (steel) - For other material please see page 6							
		M3	M4	M5	M6	M8	M10	M12	M14
RIVKLE® EP 1009	282 52 215 000	■	■	■	■				
RIVKLE® EP 2009	282 52 216 000		■	■	■	■	■		
RIVKLE® EP 3009	282 52 217 000					■	■	■	■
RIVKLE® EP 2009 PN	282 52 218 000		■	■	■	■			
RIVKLE® EP 3009 PN	282 52 219 000					■	■		

RIVKLE® EPX009 - Special accessories



Reset by key



Reset by button



Reset by RFID



Stack light repeater



Multi-energy hose



- 5 m (standard delivered)
- 10 m
- 15 m

The generic code of an RIVKLE® EP X009 configured with options is: 282 52 000 001.

See standard accessories on RIVKLE® EP X009 catalogue.

For tooling, please refer to page 22

RIVKLE® – Standard force controlled installation power hand tool

RIVKLE® B2007 - Flexible and versatile battery tool

Advantages:

- 3 kN to 22 kN (M3-M10 steel)
- Up to 800 cycles with 1 battery
- Internal testing done with 1 000 000 cycles
- BÖLLHOFF quality
- RIVKLE® blind rivet nut & stud compatible
- Li-Ion technology battery



Theory

Thanks to electro-hydraulic innovative technology, RIVKLE® B2007 features the similar technical characteristics as the RIVKLE® P2007, but in addition the battery tool offers many benefits.

Characteristics



- 1 New quick tool replacement: no tool needed. Using the existing mandrel and anvil
- 2 Electro-hydraulic technology: well balanced. Power and reliability in a reasonable weight
- 3 Soft cover for comfortable handling and for tool shock protection
- 4 LCD screen: load adjustment, setting parameters access and battery level information
- 5 Standard BÖLLHOFF ergonomics: single trigger to do the entire cycle and comfortable & ergonomic handling



Technical characteristics / Data

Maximum stroke	7,0 mm
Maximum setting force	22 kN* (* > 18 kN using appropriate accessory set)
Battery	Li-Ion / 14,4 V / 2,6 Ah
Weight without tooling	2,1 kg + 0,3 kg (Tool + battery)
Noise level	< 70 dB (A)
Production rate	24 RIVKLE®/min

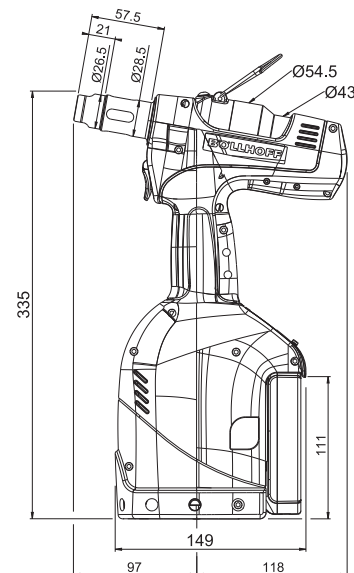
Material	Ø RIVKLE®							
	M3	M4	M5	M6	M8	M10	M12	M14
Steel	■	■	■	■	■	■	■	■
Stainless steel	■	■	■	■	■	■	■	■
Aluminium	■	■	■	■	■	■	■	■



References

Package	European plug 	North American plug 
Package with 1 battery	236 16 601 000	236 16 801 000
Package with 2 batteries	236 16 701 000	236 16 901 000

RIVKLE® B2007 stainless steel

Based on original battery tool RIVKLE® B2007, this tool is the right choice for those who prefer a battery operated tool.

Material	Ø RIVKLE®							
	M3	M4	M5	M6	M8	M10	M12	M14
Stainless steel	■	■	■	■	■	■	■	■

F = 3 000 N => 22 000 N  2490 g  236 16 601 003 (1 battery - European version)

RIVKLE® B2007 - Special accessories

					
RIVKLE® B2007	282 59 030 351	282 59 030 354	282 59 030 356	236 16 600 308	See page 23

For tooling, please refer to page 22

RIVKLE® – Full control process power hand tool

RIVKLE® EPK Compact – RIVKLE® EPK HP

Advantages:

- 100% setting (installation) process control
- Pressure setting method
- High production rate
- Multilingual touchscreen
- Adjustable alarm and security devices
- Fault management (device / process)



Theory

The RIVKLE® EPK setting tool offers a manual setting cycle with 100% quality control. This modular range answers to all integration needs (communication and production cycle management). Auto-control of setting force and setting stroke during setting process.

Characteristics



View from back side

- ① The control unit has an integrated touchscreen that enables adjustment of setting parameters, counter, alarms and manage all the sensors and multiple setting.

Options as stack light, wheels, ... are available

Technical characteristics / Data

	RIVKLE® EPK C	RIVKLE® EPK HP
Code number	282 52 000 003	
Electrical supply	230V - 50Hz	
Pneumatic supply	6 bar	
Setting force	6 to 21 kN	20 to 55 kN
Setting stroke	7 mm	9 mm
Noise level	< 70dB (A)	
Setting head weight "gun type"	2,3 Kg	
Setting head weight "vertical type"	2,5 Kg	7,5 Kg
Cycle time	3 to 4,5 s (*)	4 to 5,5 s (*)
Air consumption	300 l/min	
Power consumption	460 VA	
Production rate	13 to 20 RIVKLE®/min	11 to 15 RIVKLE®/min

(*) production rate depends on the operator and the ergonomics of the work station.

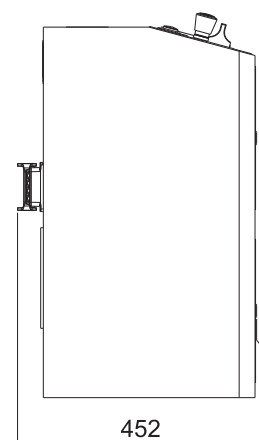
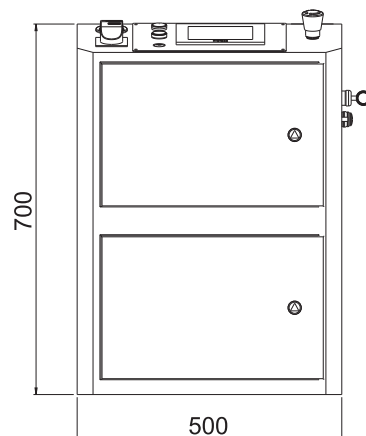

RIVKLE® EPK C Material	Ø RIVKLE®							
	M3	M4	M5	M6	M8	M10	M12	M14
Steel		■	■	■	■	■	■	■
Stainless steel		■	■	■	■	■	■	■
Aluminium				■	■	■	■	

RIVKLE® EPK HP Material	Ø RIVKLE®							
	M4	M5	M6	M8	M10	M12	M14	M16
Steel				■	■	■	■	■
Stainless steel		■	■	■	■	■	■	■
Aluminium						HRT		

RIVKLE® EPK Compact / EPK HP - Special accessories



RIVKLE® EPK C REVOLVER



RIVKLE® EPK C VERTICAL



RIVKLE® EPK C HORIZONTAL



RIVKLE® EPK C REVOLVER TOP



RIVKLE® EPK C VERTICAL 1 HAND



RIVKLE® EPK HP



RIVKLE® EPK HP HORIZONTAL



RIVKLE® EPK REVOLVER



RIVKLE® EPK VERTICAL

For tooling, please refer to page 22

RIVKLE® – Pressure controlled installation equipment

RIVKLE® - Force controller and cartridges

CARTRIDGES

It is possible to lock the setting force at a preset value on all RIVKLE® PX007 & RIVKLE® EPX009 tools using preset cartridge unit. We call it preset cartridge tool.

2 possibilities:

- 1- Order the complete tool already equipped with preset cartridge, adjusted by BÖLLHOFF using the generic code 282 52 000 005. Please indicate the type of tool you want (RIVKLE® P1007/P2007/P3007).
- 2- Order the cartridge alone and set it yourself for an existing or brand new tool, using force indicator (see page 20).

Please refer to the tab below to choose the adapted cartridge.

			
	RIVKLE® P1007	RIVKLE® P2007	RIVKLE® P3007
4 000 N	236 15 700 304	–	236 15 900 302
8 000 N	236 15 700 303	236 15 600 309	
12 000 N	236 15 700 302	236 15 600 308	
16 000 N	–	236 15 600 306	
19 000 N		236 15 600 307	
22 000 N		236 15 600 305	
Adjustment tooling kit: 236 15 600 452			

RIVKLE® FC340 - FORCE CONTROLLER

This controller indicates the direct force the tool is actually applying to the mandrel. It allows for a very precise adjustment for hydraulic/pneumatic installation tools, using colors (RIVKLE® PX007).

By frequently checking the force on the tool during production, you guarantee the quality of the setting, avoiding operator adjustments.

$$F = 3\,000\text{ N} \Rightarrow 40\,000\text{ N} \text{ (+/-3\%)}$$





 = certification



YouTube

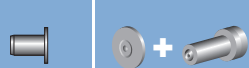

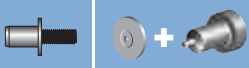
	282 52 214 000
	282 52 214 800
	282 52 214 900

TOOLING KIT		Ø RIVKLE®										
Washer + Nut			M3	M4	M5	M6	M8	M10	M12	M14	M16	
		282 52 214 1XX	03	04	05	06	08	10	12	14	16	
Washer + Nut			-	M4	M5	D5	M6	D6	M8	D8	M10	
		282 52 214 XXX	-	204	205	505	206	506	208	508	210	

Tooling for RIVKLE® UNC and RIVKLE® UNF available on demand. Select the kit for your required size.

RIVKLE® – How to?

Tooling change



Read the safety instruction manual. Disconnect from power supply (battery or air).



1- Unscrew the nose cone from the tool

Use the dedicated key from the tool box if necessary



2- To install the mandrel on the tool

2.1 - For RIVKLE® P1007 / P2007 and P3007 (& RIVKLE® EPX009)

Turn the ring so that the open end is in front of the pin hole.

Insert the mandrel into the driveshaft and align both holes to push the pin in.

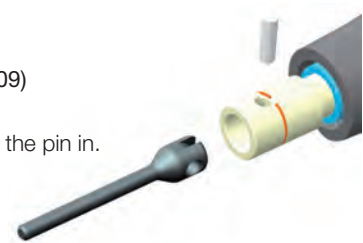

2.2 - For RIVKLE® B2007

Insert mandrel in the fork aligning the back side groove with the screwing driver (see in figure 1).

CAREFULL: grease (Multipurpose grease) has to be applied between fork and mandrel.

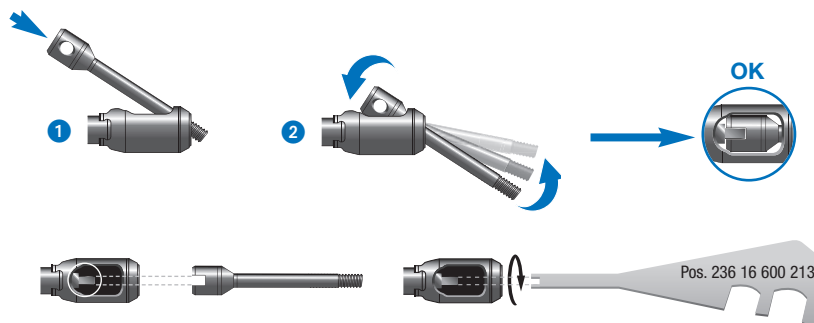

Figure 1 - Mandrel alignment

3- Retighten the nose

Tighten to about 15 Nm



4- Adjust the anvil according to RIVKLE® length

- The position of the anvil should be adjusted as shown in figures
- After adjustment, tighten the anvil locknut (2) to 10 Nm.

OPEN RIVKLE®



Flush mandrel on the end of the RIVKLE®

CLOSED END RIVKLE®



Thread root single-turn rod

RIVKLE® – Tooling for power hand tools

RIVKLE® P2005 / P1007 / P2007			📖	Ø RIVKLE®									
				M3	M4	M5	M6	M8	M10	M12	M14	M16	
Mandrel			236 11 3XX 020	03	04	05	06	08	10	*(1)	-	-	
			376 11 3XX 020	-	04	05	06	08	*(3)	-	-	-	
Anvil			236 11 3XX 030	03	04	05	06	08	10	*(2)	-	-	
			376 11 3XX 030	-	04	05	06	08	*(4)	-	-	-	

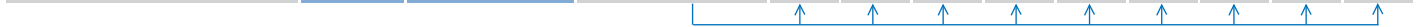

RIVKLE® B2007			📖	3 → 18 kN					18 → 22 kN	
				M3	M4	M5	M6	M8	M8	M10
Mandrel			236 11 3XX 020	03	04	05	06	08	236 91 308 110	236 91 310 019
			376 11 3XX 020	-	04	05	06	08	-	
Anvil			236 11 3XX 030	03	04	05	06	08	08	10
			376 11 3XX 030	-	04	05	06	08	-	
Nose for studs & force >18 kN (M8 & M10)			236 16 600 303						✓	✓
Fork for studs & force >18 kN (M8 & M10)			236 16 600 304							

RIVKLE® P2005 / P1007 / P2007			📖	Ø RIVKLE® - UNC					Ø RIVKLE® - UNF			
				4-40	6-32	8-32	10-24	1/4-20	10-32	1/4-28	7/16-20	3/8-24
Mandrel			236 11 3XX XXX	65 620	67 620	68 620	69 620	74 620	69 720	74 720	78 720	77 720
Anvil			236 11 3XX XXX	03 030	67 030	68 030	69 030	74 030	69 030	74 030	*(6)	77 030

RIVKLE® P2007 PN			📖	Ø RIVKLE®									
				M3	M4	M5	M6	M8	M10	M12	M14	M16	
Mandrel			236 91 3XX XXX	-	04 094	05 094	06 127	08 101	*(5)	-	-	-	
Anvil			236 91 3XX XXX	-	04 086	05 095	06 128	08 087	10 010	-	-	-	

*(1) = 236 15 312 020 *(2) = 236 15 312 030 *(3) = 376 91 310 020 *(4) = 376 91 310 030 *(5) = 236 91 310 006 *(6) = 236 92 378 030

RIVKLE® TOOLING BOX			📖	Ø RIVKLE®									
				M3	M4	M5	M6	M8	M10	M12	M14	M16	
			236 11 300 001	✓	✓	✓	✓	✓	✓	✓	-	-	
				-	✓	✓ +D5	✓ +D6	✓ +D8	-	-	-	-	
			236 11 300 002	✓	✓	✓	✓	✓	-	-	-	-	

Accessories

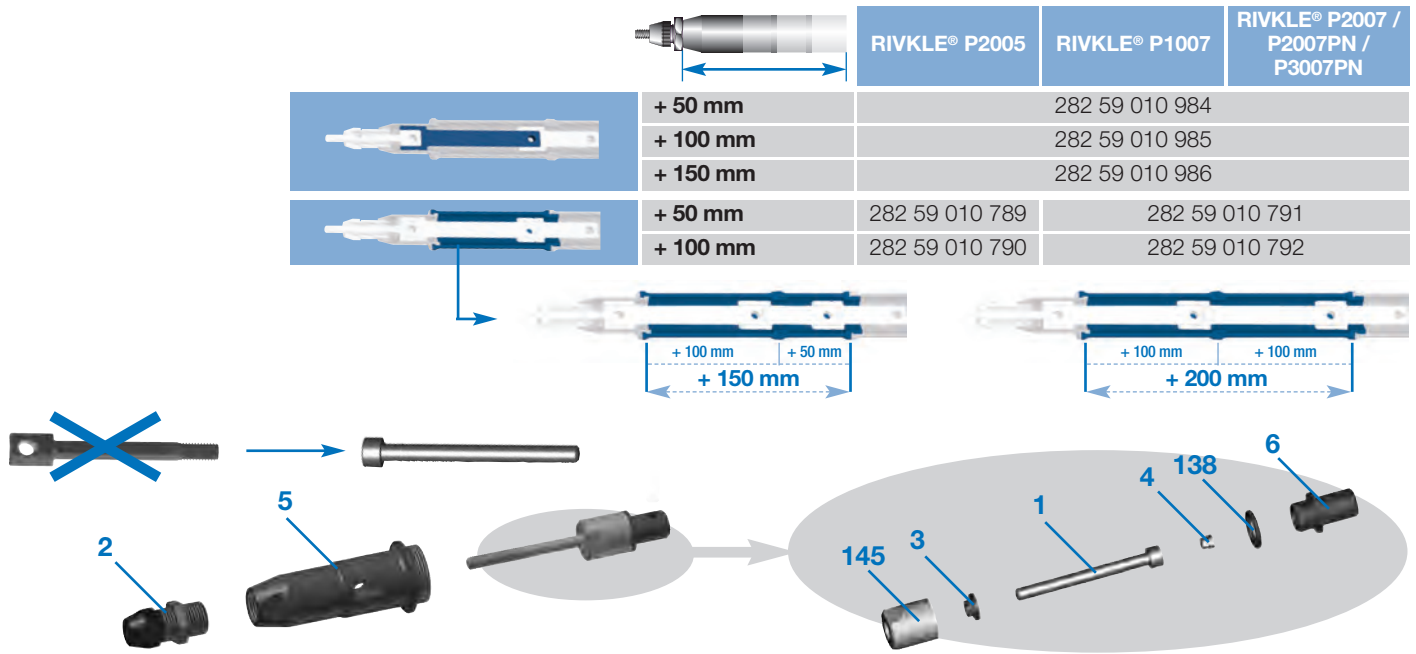

Ø	KIT = A + B + C				
	A		B		C
	RIVKLE® B2007 = original nose		145 + 138 + 6		1 + 2 + 3 + 4
	RIVKLE® P2005	RIVKLE® P1007	RIVKLE® P2007	PX007 + P2005	RIVKLE® B2007
M3					236 80 303 000
M4					236 80 304 000
M5	236 15 300 043	236 15 700 309	236 80 300 005	236 80 300 216	236 80 305 000
M6					236 80 306 000
M8					236 80 308 000

Ø	ISO4762 DIN912	2	3	4
M3	M3 x 60 → 236 80 303 020	236 11 303 030	236 80 303 040	236 80 303 010
M4	M4 x 60 → 236 80 304 020	236 11 304 030	236 80 304 040	236 80 304 010
M5	M5 x 65 → 236 80 305 020	236 11 305 030	236 80 305 040	236 80 305 010
M6	M6 x 65 → 236 80 306 020	236 11 306 030	236 80 306 040	236 80 306 010
M8	M8 x 70 → 236 80 308 020	236 11 308 030	–	236 80 308 010

		RIVKLE® P1007 / 2007	RIVKLE® P3007
Ring		236 80 300 008	236 15 900 003
Pin		236 80 300 009	236 15 900 004

Refill & purge accessory

RIVKLE® P1007 / P2007 / P3007 / P2005		236 11 400 970
RIVKLE® B2007		236 16 600 309

BÖLLHOFF

Worldwide for you a strong partner – at 39 locations in 24 countries.

Böllhoff Group

Please find your local contact on www.boellhoff.com
or contact us under fasteningtechnology@boellhoff.com

